

Installation and Operating Instructions for Model:

**Save these instructions for future use!**

**FAILURE TO READ AND FOLLOW ALL INSTRUCTIONS CAREFULLY BEFORE INSTALLING OR OPERATING THIS CONTROL COULD CAUSE PERSONAL INJURY AND/OR PROPERTY DAMAGE.**

Model	Programming Choices		
1F97-1271	Non-Programmable	5/1/1 Day	7 Day

**APPLICATIONS**

**THERMOSTAT APPLICATION GUIDE**

Description	
Heat Pump (No Aux. or Emergency Heat)	Yes
Heat Pump (with Aux. or Emergency Heat)	No
Standard Heat & Cooling Systems	Yes
Systems requiring more than One Call for Heat or Cool	No
Standard Heat Only Systems	Yes
Millivolt Heat Only Systems – Floor or Wall Furnaces	Yes
Standard Central Air Conditioning	Yes
Gas or Oil Heat	Yes
Electric Furnace	Yes
Hydronic (Hot Water) Zone Heat – 2 Wires	Yes
Hydronic (Hot Water) Zone Heat – 3 Wires	No

1F97-1271 Touchscreen Thermostat



**SPECIFICATIONS**

Electrical Rating Single Stage:	
Battery Power	mV to 30 VAC, NEC Class II, 50/60 Hz or DC
Input-Hardwire	20 to 30 VAC
Terminal Load	1.0 A per terminal, 1.5A maximum all terminals combined
Setpoint Range	45 to 99°F (7 to 32°C)
Rated Differential (Single Stage)	Heat 0.6°F; Cool 1.2°F
Operating Ambient	32° to +105°F (0 to +41°C)
Operating Humidity	90% non-condensing max.
Shipping Temperature Range	-4 to +150°F (-20 to +65°C)
Dimensions Thermostat	4.6"H x 5.9"W x 1.2"D

**CAUTION**

To prevent electrical shock and/or equipment damage, disconnect electric power to system at main fuse or circuit breaker box until installation is complete.

**ATTENTION: MERCURY NOTICE**

This product does not contain mercury. However, this product may replace a product that contains mercury.

Mercury and products containing mercury must not be discarded in household trash. Do not touch any spilled mercury. Wearing non-absorbent gloves, clean up any spilled mercury and place in a sealed container. For proper disposal of a product containing mercury or a sealed container of spilled mercury, place it in a suitable shipping container and send it to:

**White-Rodgers**  
2895 Harrison Street  
Batesville AR 72501

Index	Page
Installation	2
Wiring Connections	2
Thermostat Quick Reference	3
Installer Configuration Menu	4
Operating Your Thermostat	6
Programming	6
Troubleshooting	8

# INSTALLATION

## ⚠ WARNING

Thermostat installation and all components of the control system shall conform to Class II circuits per the NEC code.

### Remove Old Thermostat

A standard heat/cool thermostat consists of three basic parts:

1. The cover, which may be either a snap-on or hinge type.
2. The base, which is removed by loosening all captive screws.
3. The switching subbase, which is removed by unscrewing the mounting screws that hold it on the wall or adapter plate. **Before removing wires from old thermostat, label each wire with the terminal designation from which it was attached.** Disconnect the wires from the old thermostat one at a time. **Do not let wires fall back into the wall.**

### Installing New Thermostat

1. Pull the thermostat body off the thermostat base. Forcing or prying on the thermostat will cause damage to the unit.
2. Place base over hole in wall and mark mounting hole locations on wall using base as a template.
3. Move base out of the way. Drill mounting holes. If you are using existing mounting holes and the holes drilled are too large and do not allow you to tighten base snugly, use plastic screw anchors to secure the base.
4. Fasten base snugly to wall using mounting holes shown in Figure 1 and two mounting screws. Leveling is for appearance only and will not affect thermostat operation.
5. Connect wires to terminal block on base using appropriate wiring schematic (see Figures 2 & 3).

6. Push excess wire into wall and plug hole with a fire resistant material (such as fiberglass insulation) to prevent drafts from affecting thermostat operation.
7. Carefully line the thermostat up with the base and snap into place.

### Battery Location

2 "AA" alkaline batteries are included in the thermostat at the factory with a battery tag to prevent power drainage. Remove the battery tag to engage the batteries.

To replace batteries, set system to **OFF**, remove thermostat from wall and install the batteries in the rear along the top of the thermostat (see Figure 1).

Figure 1 – Thermostat base and rear view of thermostat

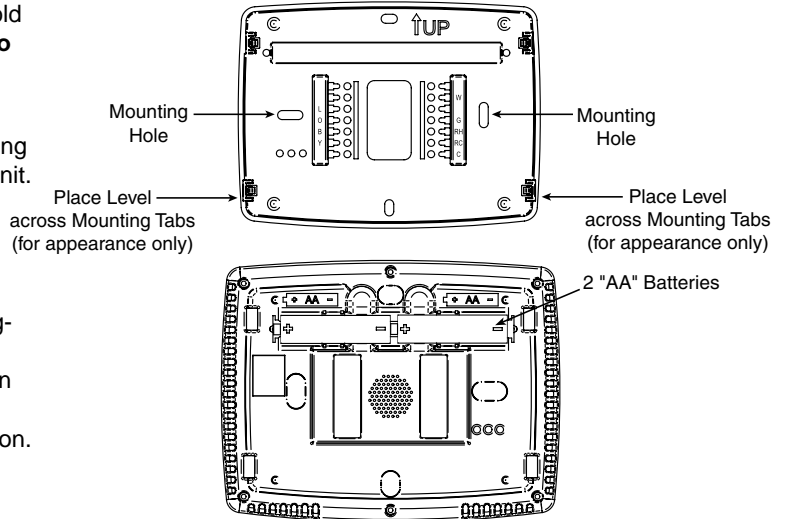

## WIRING CONNECTIONS

Refer to equipment manufacturers' instructions for specific system wiring information. After wiring, see CONFIGURATION section for proper thermostat configuration.

Wiring diagrams shown are for typical systems and describe the thermostat terminal functions.

### TERMINAL DESIGNATION DESCRIPTIONS

Terminal Designation	Description	Terminal Designation	Description
W	Heat Relay	L	Heat pump malfunction indicator for systems with malfunction connection
G	Fan Relay	O	Changeover valve for heat pump energized constantly in cooling
RH	Power for Heating	B	Changeover valve for heat pump energized constantly in heating
RC	Power for Cooling	Y	Compressor Relay
C	Common wire from secondary side of cooling system transformer or heat only system transformer		

Figure 2 – Two Transformer System

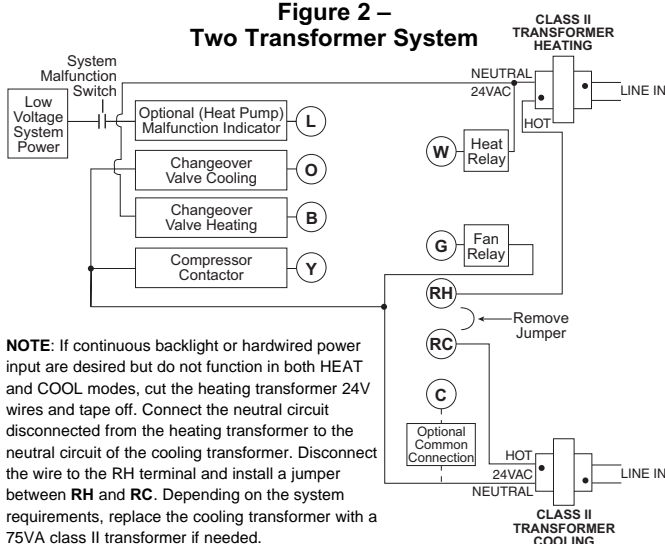
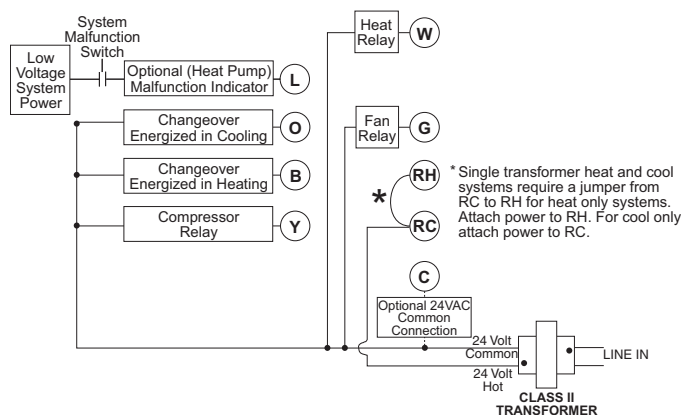

Figure 3 – Single Transformer System



**NOTE:** Heat Pump without Aux: If using L for MALT indicator, C must be connected. Terminals W and Y must be jumpered and CR HEAT must be selected to SL in Configuration Menu item 6.

# THERMOSTAT QUICK REFERENCE

## Home Screen Description

Figure 4 – Home Screen Display

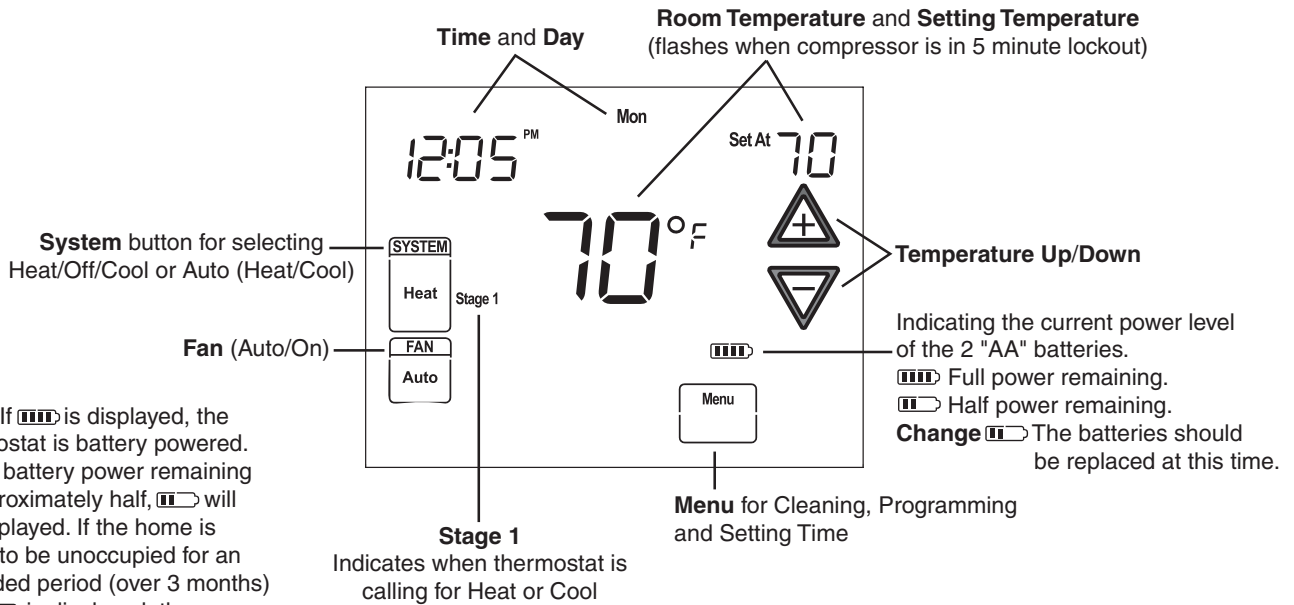

**Note:** If [||||] is displayed, the thermostat is battery powered. When battery power remaining is approximately half, [||| ] will be displayed. If the home is going to be unoccupied for an extended period (over 3 months) and [||| ] is displayed, the batteries should be replaced before leaving.

Figure 5 – Programming & Configuration Items

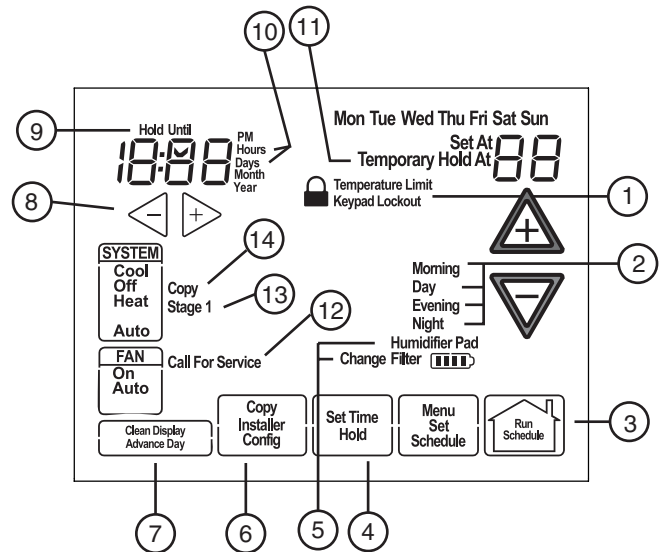

## Programming and Configuration Items

- ① Displays and "Keypad Lockout" when in keypad lockout mode. Displays and "Temperature Limit" and "Keypad Lockout" when limited range is activated and locked. Displays only "Temperature Limit" when limited range is activated.
- ② Indicates period of day being programmed.
- ③ RUN SCHEDULE (run program) button.
- ④ SET TIME button or HOLD temperature button.
- ⑤ Displays "Change Filter" when the system has run for the programmed filter time period as a reminder to change or clean your filter. Displays "Humidifier Pad" when the system has run for the programmed filter time period as a reminder to change or clean your humidifier pad.
- ⑥ COPY button or INSTALLER CONFIG button.
- ⑦ CLEAN DISPLAY button allows 30 seconds to wipe off the display or ADVANCE DAY button for programming.
- ⑧ Used in programming to set time and in configuration menu to change selections.
- ⑨ "Hold Until" indicates the time when a temporary hold period will end.
- ⑩ "Hours" and "Days" displays during steps in installer configuration.
- ⑪ The words "Hold At" are displayed when the thermostat is in the **HOLD** mode. "Temporary Hold At" is displayed when the thermostat is in a temporary **HOLD** mode.
- ⑫ "Call For Service" indicates a fault in the heating/cooling system. It does not indicate a fault in the thermostat.
- ⑬ "Stage 1" indicates when heating or cooling stage is energized.
- ⑭ "Copy" indicates the copy program feature is being used during programming.

# INSTALLER/CONFIGURATION MENU





















To enter the menu: Press the **Menu** button. Press and hold for 5 seconds the **Installer Config** button this displays menu item #1 in the table below. Press  $\Delta$  to advance to the next menu item or  $\nabla$  to return to a previous menu item. Press  $\triangleright$  or  $\triangleleft$  to change a menu item.

CONFIGURATION MENU						
Menu Reference Number	7 Day	Non-Programmable	Press Button	Displayed (Factory Default)	Press $\triangleright$ or $\triangleleft$ to select from listed options	Comments
1	1	1		(GAS)	ELE	GAS setting: furnace controls blower. ELE setting: thermostat controls blower.
2	2	2	$\Delta$	Days (7)	5, 0	Selects programming option.
3	3	* NA	$\Delta$	PS (4)	2	Selects programming periods per day.
4	4	3	$\Delta$	Cool, Off, Heat, Auto	Cool, Off, Heat, Off, Heat, Cool, Off	Selects system switch configuration for heat and cool with Auto changeover, Heat & Cool, Heat Only or Cool Only.
5	5	* NA	$\Delta$	E (On)	OFF	Selects Energy Management Recovery on or off.
6	6	4	$\Delta$	Cr Heat (FA)	SL	Selects Heat cycle rate Fast (FA) or Slow (SL).
7	7	5	$\Delta$	Cr Cool (FA)	SL	Selects Cool cycle rate Fast (FA) or Slow (SL).
8	8	6	$\Delta$	CL (OFF)	On	Selects Compressor lockout ON or OFF.
9	9	7	$\Delta$	dL (On)	OFF	Selects display light on or off.
10	10	8	$\Delta$	0 (Room temp)	1, 2, 3, 4 HI 1, 2, 3, 4 LO	Selects temperature display adjustment 1, 2, 3 or 4 degrees high or low.
11	11	9	$\Delta$	°F	°C	Selects Fahrenheit or Celsius temperature display.
12	12	10	$\Delta$	b (On)	OFF	Selects beeper on or off.
13	13	11	$\Delta$	Heat (99)	62-99	Selects highest Heat setpoint temperature. Can select 62° to 99°F.
14	14	12	$\Delta$	Cool (45)	45-82	Selects lowest Cool setpoint temperature. Can select 45° to 82°F.
15	15	13	$\Delta$	Keypad lockout (L)	L, P Temperature Limit	Selects keypad lockout full or partial to be set. Activates temperature limit ranges.
16	16	14	$\Delta$	Keypad lockout (OFF)	On	Selects keypad lockout on or off.
				000	000 to 999	Selects keypad lockout combination number if lockout is on. 000 is not a valid selection.
17	17	15	$\Delta$	000 Change Filter (OFF)	On	Select change filter alert time period.
				200 hours	25 to 1975 hours	When set ON, selects time in 25 hour increments.
18	18	16	$\Delta$	Change Humidifier (OFF)	On	Selects change humidifier pad alert time period
				100 hours	25 to 1975 hours	When set ON, selects time in 25 hour increments.

\* Not Applicable

- 1) GAS or Electric (ELE) fan operation. If the heating system requires the thermostat to energize the fan, select ELE. Select GAS if the heating system energizes the fan on a call for heat. Note: Resetting the thermostat switches the option to ELE.
- 2) This control can be configured for 7 independent day or 5/1/1 programming or non-programmable mode. The display indicates "7 Days" as default. The programs per week can be toggled to "5 Days" or "0 Days" by pressing the  $\triangleright$  or  $\triangleleft$  keys. A selection of 0 Days for non-programmable will eliminate the need for EMR, and that step in the menu will be skipped.
- 3) **Programmable Periods** – This control can be configured for 4 or 2 programmable periods per day. The display indicates "4 PS" in the display as default. The programmable periods can be toggled by pressing the  $\triangleright$  or  $\triangleleft$  keys.
- 4) **System Switch Configuration** – This thermostat is configured for Heat and Cool with Auto changeover (SYSTEM switch with Cool Off Heat Auto) default. It can also be configured for Heat and Cool (Cool Off Heat), Heat only (Off Heat), and Cool only (Cool Off).
- 5) **Energy Management Recovery** – (this step is skipped if configured to be non-programmable). Energy Management Recovery (E) On causes the thermostat to start heating or cooling early to make the building temperature reach the program setpoint at the time you specify. Heating will start 5 minutes early for every 1° of temperature required to reach setpoint. **Example:** E On is selected and your heating is programmed to 65° at night and 70° at 7 AM. If the building temperature is 65°, the difference between 65° and 70° is 5°. Allowing 5 minutes per degree, the thermostat setpoint will change to 70° at 6:35 AM. Cooling allows more time per degree, because it takes longer to reach temperature.

## INSTALLER/CONFIGURATION MENU

- 6 & 7) **Fast or Slow Cycle Selection** – The factory default setting for Heat is fast cycle (FA), which cycles heat at approximately 0.6°F. If you prefer slow cycle, press the  or  key to change to SL. Heat will cycle at approximately 1.2°F. For Cool the default setting is fast cycle (FA), which cycles cool at approximately 1.2°F. If you prefer slow cycle, press the  or  key to change to SL, cool will cycle at approximately 1.7°F.
- 8) **Select Compressor Lockout CL OFF or ON** – Selecting CL ON will cause the thermostat to wait 5 minutes between cooling cycles. This is intended to help protect the compressor from short cycling. Some newer compressors already have a time delay built in and do not require this feature. Your compressor manufacturer can tell you if the lockout feature is already present in their system. When the thermostat compressor time delay occurs, it will flash the setpoint for up to five minutes. When CL is ON and 24V common (C) is connected, the lockout feature will prevent compressor start after a 24V power interruption of less than 5 minutes. This will assure a 5-minute delay to prevent premature compressor failure.
- 9) **Select Backlight Display** – The display backlight improves display contrast in low lighting conditions. When the C terminal is powered, selecting backlight (dL ON) will turn the light on continuously. Selecting backlight OFF will turn the light on momentarily after any key is pressed. When the C terminal is not powered, this selection has no effect.
- 10) **Select Temperature Display Adjustment 4 LO to 4 HI** Allows you to adjust the room temperature display up to 4° higher or lower. Your thermostat was accurately calibrated at the factory, but you have the option to change the display temperature to match your previous thermostat. The current or adjusted room temperature will be displayed on the left side of the display.
- 11) **Select F° or C° Readout** – Changes the display readout to Centigrade or Fahrenheit as required.
- 12) **Select Audio Prompting (Beeper) On or Off** – Default setting is On (On b) if you wish to turn off the beeper select Off b.
- 13) **Heat Temperature Limit Range** – This feature adjusts the highest setpoint temperature for heat. The default setting is 99°F. It can be changed between 62°F and 98°F by pressing the  or  key. The "temperature limit" icon will be displayed to the left of your setpoint temperature when using this feature. The "temperature limit" icon will flash if an attempt is made to adjust the temperature beyond the range selected.
- 14) **Cool Temperature Limit Range** – This feature adjusts the lowest setpoint temperature for cool. The default setting is 45°F. It can be changed between 46°F and 82°F by pressing the  or  key. The "temperature limit" icon will be displayed to the left of your setpoint temperature when using this feature. The "temperature limit" icon will flash if an attempt is made to adjust the temperature beyond the range selected.
- 15) **Keypad Lockout** – This step allows you to select the type of lockout or limited range security required. If no lockout or limited range security is required, press  to advance the menu. Three security settings are available in this menu item. Use the  or  keys to select the lockout desired. Lockout selections are:  
"Keypad Lockout and L" = Total Lockout. Total Lockout locks all keys.  
"Keypad Lockout and P" = Partial Lockout. Partial Lockout allows only the  or  keys to operate within your set temperature limits.  
"Temperature Limit/Keypad Lockout" prevents changing the temperature limits in the Configuration Menu.
- 16) **Keypad Lockout Combination Number Selection** Display will read "OFF" "Keypad Lockout". Skip this step and continue through the configuration menu items 17 and 18 if you require an Air Filter Change out indicator or Humidifier Pad Change out indicator by pressing the  button to advance. Return to this point when you are ready to start your selected lock-out and continue by:  
Pressing  or  keys to select ON.  
Press . Display will read "000".  
Pressing  or  keys to select your keypad lockout combination number. Note: "000" is not a valid combination choice.  
**Record the number you select for future use.**  
Press  to exit the menu. The security feature you select will start in 10 seconds. The system button will remain active for 10 seconds to allow setting Heat, Off, Cool or Auto.
- 17) **Select Filter Replacement Run Time** – The thermostat will display "Change Filter" after a set time of blower operation. This is a reminder to change or clean your air filter. This time can be set from 25 to 1975 hours in 25 hour increments. A selection of OFF will cancel this feature. When "Change Filter" is displayed, you can clear it by pressing Clean Display. In a typical application, 200 hours of run time is approximately 30 days.
- 18) **Select Humidifier Pad Replacement Run Time** – The thermostat will display "Change Humidifier Pad" after a set time of humidifier operation. This is a reminder to change or clean your humidifier pad. This time can be set from 25 to 1975 hours in 25 hour increments. A selection of OFF will cancel this feature. When "Change Humidifier Pad" is displayed, you can clear it by pressing Clean Display. Check with your humidifier manufacturer for a recommended maintenance interval.



## OPERATING YOUR THERMOSTAT

## IMPORTANT!

### Choose the Fan Setting (Auto or On)

Set the FAN Switch to **Auto** or **On**.

Fan **Auto** is the most commonly selected setting and runs the fan only when the heating or cooling system is on.

Fan **On** runs the fan continuously for increased air circulation or to allow additional air cleaning.

### Choose the System Setting (Heat, Off, Cool, Auto)

Press the SYSTEM button to select:

**Heat:** Thermostat controls only the heating system.

**Off:** Heating and Cooling systems are off.

**Cool:** Thermostat controls only the cooling system.

**Auto:** Auto Changeover is used in areas where both heating and cooling may be required on the same day. **AUTO** allows the thermostat to automatically select heating or cooling depending on the indoor temperature and the selected heat and cool temperatures. When using **AUTO**, be sure to set the Cooling temperatures more than 1° Fahrenheit higher than the heating temperature.

### Manual Operation for Non-Programmable Thermostats

**Press** the SYSTEM button to select Heat or Cool and use the  $\blacktriangle$  or  $\blacktriangledown$  buttons to adjust the temperature to your desired setting. After selecting your desired settings you can also press the SYSTEM button to select **AUTO** to allow the thermostat to automatically change between Heat and Cool.

### Manual Operation (Bypassing the Program) Programmable Thermostats

Press  $\blacktriangle$  or  $\blacktriangledown$  and the HOLD button, then adjust the temperature wherever you like. This will override the program. The **HOLD** feature bypasses the program and allows you to adjust the temperature manually, as needed. Whatever temperature you set in **HOLD** will be maintained 24 hours a day, until you manually change the temperature or press **Run Schedule** to cancel **HOLD** and resume the programmed schedule.

### Program Override (Temporary Override)

Press  $\blacktriangle$  or  $\blacktriangledown$  buttons to adjust the temperature. This will override the temperature setting for a (default) four hour override period. The override period can be shortened by pressing  $\blacktriangleleft$  or lengthened by pressing  $\blacktriangleright$ . Program Override period can range from 15 minutes to 7 days.

**Example:** If you turn up the heat during the morning program, it will be automatically lowered later, when the temporary hold period ends. To cancel the temporary setting at any time and return to the program, press **Run Schedule**.

If the SYSTEM button is pressed to select **AUTO** the thermostat will change to Heat or Cool, whichever ran last. If it switches to heat but you want cool, or it changes to cool but you want heat, press both  $\blacktriangle$  and  $\blacktriangledown$  buttons simultaneously to change to the other mode.

## PROGRAMMING

### Set Current Time and Day

- 1) Press Menu and then Set Time button once. The display will show the hour only.
- 2) Press and hold either the  $\blacktriangleright$  or  $\blacktriangleleft$  key until you reach the correct hour and AM/PM designation (AM begins at midnight, PM begins at noon).
- 3) Press Set Time once again. The display window will show the minutes only.
- 4) Press and hold either the  $\blacktriangleright$  or  $\blacktriangleleft$  key until you reach the correct minutes.
- 5) Press Set Time once again. The display will show the day of the week.
- 6) Press the  $\blacktriangleright$  or  $\blacktriangleleft$  key until you reach the current day of the week.
- 7) Press Run Schedule once. The display will show the correct time and room temperature alternately.

### Programming Tip: Copy Button

You may copy any daily program to another day or group of days by pressing the Copy button. In 7 day programming mode when the Copy button is pressed, the other 6 days of the week will flash. To copy the current program into the remaining six days, simply press the Copy button again. To copy the current program to another day of the week, press Advance Day to select the day and press Copy to paste the program. In 5/1/1 day programming mode the copy function is similar. The weekday (Mon-Fri) program can be copied to Sat and Sun (both flashing) or use Advance Day to choose Sat or Sun and press the Copy button to paste the program.

Fill in the blank schedule on the next page then:

### Enter the Heating Program

- 1) Press the Menu button and then press Set Schedule. Press SYSTEM button to select "**Heat**" in the system switch area indicating the active mode being programmed.
- 2) The top of the display will show the day(s) being programmed. The time and set at temperature are also displayed. "**Morning**" will also be displayed to indicate the period.
- 3) Press  $\blacktriangle$  or  $\blacktriangledown$  key to change the temperature to your selected temperature for the 1st heating period (Morning).
- 4) Press  $\blacktriangleright$  or  $\blacktriangleleft$  key to adjust the start time for period.
- 5) The time will change in 15 minute increments.
- 6) After you have set the time and the temperature for the period to begin, press Set Schedule to advance to the next program period.
- 7) Repeat steps 2 through 6 until all of the program times and temperatures are set for all program periods on that day.
- 8) Press "Advance Day" to change to the next day and repeat steps 2 through 8.
- 9) When programming is complete and all of the times and temperatures match your desired heating schedule, press Run Schedule. The thermostat will now run your program.

### Enter the Cooling Program

- 1) Press SYSTEM button to select "**Cool**" in the system switch area indicating the active mode being programmed.
- 2) Follow **Enter Heating Program** instructions for entering cooling times and temperatures.

# PROGRAMMING

## Energy Saving Factory Pre-Program

The 1F97-1271 thermostats are programmed with the energy saving settings shown in the table below for all days of the week. If this program suits your needs, simply set the thermostat clock and press the RUN button.

The table below shows the factory set heating and cooling schedule for all days of the week.

	* Wake Up (Morning)		Leave For Work (Day)		* Return Home (Evening)		Go To Bed (Night)	
<b>Heating Program</b>	6:00 AM	70°F	8:00 AM	62°F	5:00 PM	70°F	10:00 PM	62°F
<b>Cooling Program</b>	6:00 AM	78°F	8:00 AM	85°F	5:00 PM	78°F	10:00 PM	82°F

\* You can eliminate these two program periods in the configuration menu (reference #3) if the building is occupied all day. Day will change to 6:00 am and can be programmed as required.

## Planning Your Program – Important

The Heating and Cooling Program schedules below allow you to pencil in your own program times and temperatures.

The 1F97-1271 comes configured for 7 day programming and can also be configured for 5+1+1 programming (see configuration section).

Factory settings are listed on Monday, Saturday and Sunday. If you are re-programming a 5+1+1 day schedule, pencil in your own times and temperatures directly below the factory times and temperatures.

If you are re-programming a 7 day fill in all lines with the times and temperatures you want.

Keep the following guidelines in mind when planning your program.

- In Heating, lower temperatures will save energy.
- In Cooling, higher temperatures will save energy.
- If you plan on using Auto Changeover, do not program the heating higher than the cooling.

## Worksheet for Re-Programming 5+1+1 and 7 Day Program



Heating Program	Wake Up (Morning)		Leave For Work (Day)		Return Home (Evening)		Go To Bed (Night)	
<b>MON</b>	6:00 AM	70°F	8:00 AM	62°F	5:00 PM	70°F	10:00 PM	62°F
<b>TUE</b>								
<b>WED</b>								
<b>THU</b>								
<b>FRI</b>								
<b>SAT</b>	6:00 AM	70°F	8:00 AM	62°F	6:00 PM	70°F	10:00 PM	62°F
<b>SUN</b>	6:00 AM	70°F	8:00 AM	62°F	6:00 PM	70°F	10:00 PM	62°F

Cooling Program	Wake Up (Morning)		Leave For Work (Day)		Return Home (Evening)		Go To Bed (Night)	
<b>MON</b>	6:00 AM	78°F	8:00 AM	85°F	5:00 PM	78°F	10:00 PM	82°F
<b>TUE</b>								
<b>WED</b>								
<b>THU</b>								
<b>FRI</b>								
<b>SAT</b>	6:00 AM	78°F	8:00 AM	85°F	5:00 PM	78°F	10:00 PM	82°F
<b>SUN</b>	6:00 AM	78°F	8:00 AM	85°F	5:00 PM	78°F	10:00 PM	82°F

# TROUBLESHOOTING

## Reset Operation

If a voltage spike or static discharge blanks out the display or causes erratic thermostat operation, you can reset the thermostat by removing the wires from terminals **R** and **C** (do not short them together) and removing batteries for 2 minutes. After resetting the thermostat, replace the wires and batteries. If the thermostat has been reset and still does not function correctly contact your heating/cooling service person or place of purchase.

To reset the programming, clock and configuration settings, press  and  and the **SYSTEM** button simultaneously. The thermostat should go blank and then all segments will be displayed momentarily.

Symptom	Possible Cause	Corrective Action
<b>No Heat/No Cool/No Fan (common problems)</b>	<ol style="list-style-type: none"> <li>Blown fuse or tripped circuit breaker.</li> <li>Furnace power switch to OFF.</li> <li>Furnace blower compartment door or panel loose or not properly installed.</li> <li>Loose connection to thermostat or system.</li> </ol>	Replace fuse or reset breaker. Turn switch to ON. Replace door panel in proper position to engage safety interlock or door switch. Tighten connections.
<b>No Heat</b>	<ol style="list-style-type: none"> <li>Pilot light not lit.</li> <li>Furnace Lock-Out Condition. Heat may also be intermittent.</li> <li>Heating system requires service or thermostat requires replacement.</li> </ol>	Re-light pilot. Many furnaces have safety devices that shut down when a lock-out condition occurs. If the heat works intermittently contact the furnace manufacturer or local HVAC service person for assistance. <b>Diagnostic:</b> Set SYSTEM Switch to <b>HEAT</b> and raise the setpoint above room temperature. Within a few seconds the thermostat should make a soft click sound. This sound usually indicates the thermostat is operating properly. If the thermostat does not click, try the reset operation listed above. If the thermostat does not click after being reset contact your heating and cooling service person or place of purchase for a replacement. If the thermostat clicks, contact the furnace manufacturer or a HVAC service person to verify the heating is operating correctly.
<b>No Cool</b>	<ol style="list-style-type: none"> <li>Cooling system requires service or thermostat requires replacement.</li> </ol>	Same as diagnostic for No Heat condition except set the thermostat to <b>COOL</b> and lower the setpoint below the room temperature. There may be up to a five minute delay before the thermostat clicks in Cooling.
<b>Heat, Cool or Fan Runs Constantly</b>	<ol style="list-style-type: none"> <li>Possible short in wiring.</li> <li>Possible short in thermostat.</li> <li>Possible short in heat/cool/fan system.</li> <li>FAN Switch set to Fan <b>ON</b>.</li> </ol>	Check each wire connection to verify they are not shorted or touching together. No bare wire should stick out from under terminal block. Try resetting the thermostat as described above. If the condition persists the manufacturer of your system or service person can instruct you on how to test the Heat/Cool system for correct operation. If the system operates correctly, replace the thermostat.
<b>Thermostat Setting &amp; Thermostat Thermometer Disagree</b>	<ol style="list-style-type: none"> <li>Thermostat thermometer setting requires adjustment.</li> </ol>	The thermometer can be adjusted +/- 4 degrees. See Temperature Display Adjustment in the Configuration Menu section.
<b>Furnace (Air Conditioner) Cycles Too Fast or Too Slow (narrow or wide temperature swing)</b>	<ol style="list-style-type: none"> <li>The location of the thermostat and/or the size of the Heating System may be influencing the cycle rate.</li> </ol>	Digital thermostats provide precise control and cycle faster than older mechanical models. The system turns on and off more frequently but runs for a shorter time so there is no increase in energy use. If you would like an increased cycle time, choose <b>SL</b> for slow cycle in the Configuration menu, step 6 (heat) or 7 (cool). If an acceptable cycle rate is not achieved, contact a local HVAC service person for additional suggestions.
<b>Forgot Keypad Lockout Code</b>		Press the Menu button (button will disappear) and hold in for 15 to 20 seconds. This unlocks the thermostat.

**HOMEOWNER HELP LINE: 1-800-284-2925**

White-Rodgers is a division of Emerson Electric Co.

The Emerson logo is a trademark and service mark of Emerson Electric Co.

White  
  
 Rodgers

St. Louis, Missouri

[www.white-rodgers.com](http://www.white-rodgers.com)

